

U70 FLAT PANEL MOUNT SPECIFICATION SHEET

MAX TOTAL WEIGHT 250 LBS / 113.39 KG

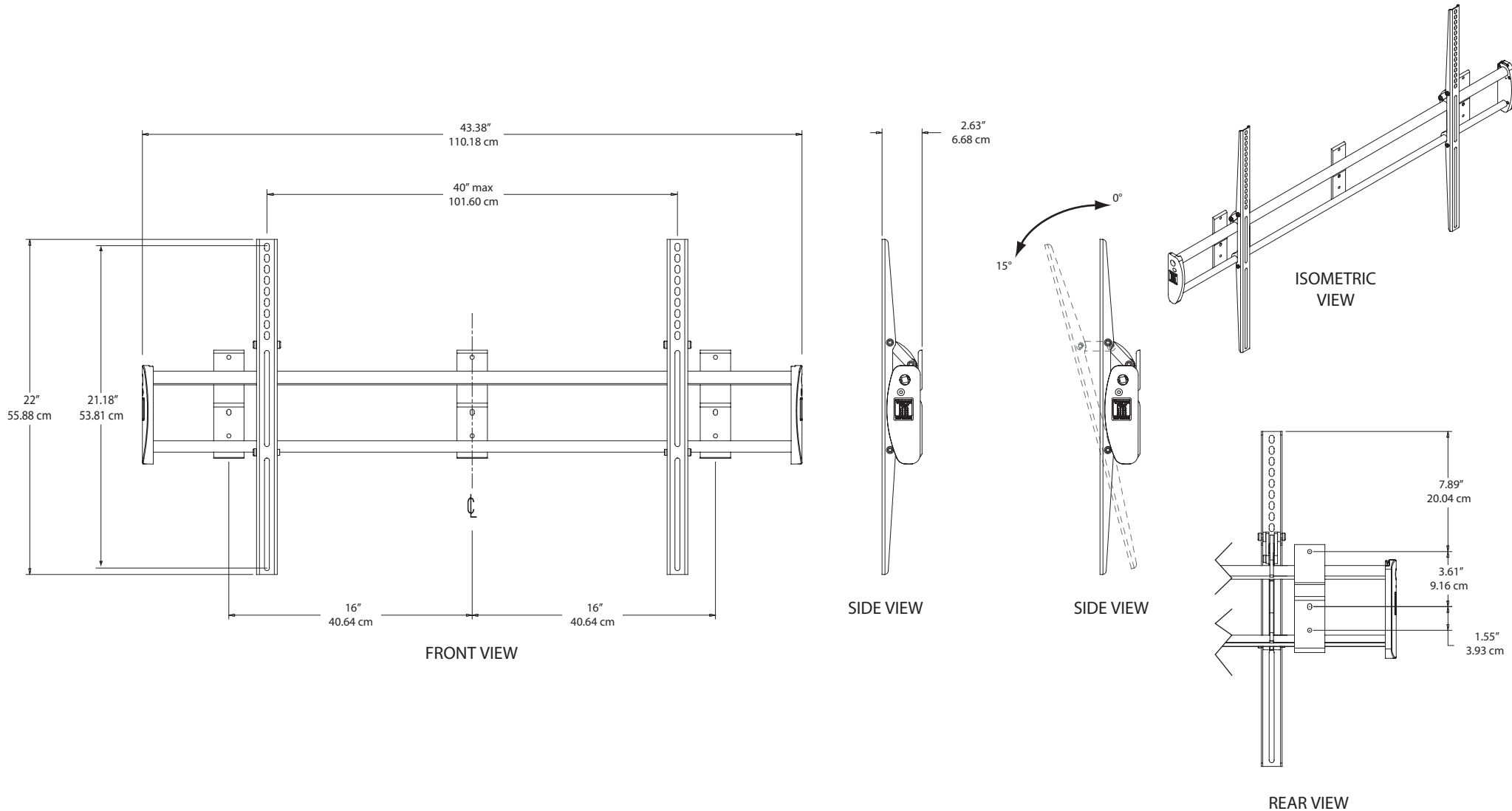

Vantage Point Products Corp. 10233 Palm Drive Santa Fe Springs, CA 90670
 USA: 800.582.9595 Canada: 905.607.9994 Europe: 31.72.581.6056
 Email: cons-serv@vanptc.com Website: www.vanptc.com